

CODE NUMBER

3315094BT

DESCRIPTION

Bluetooth, 4" Trim Plate, Battery Power Supply, Below Deck
 Thermostatic Mixing Valve, Polished Chrome Finish, 0.5 gpm, Multi-
 Laminal Spray, Infrared Sensor, Optima® Battery or Turbine-Powered
 Deck-Mounted Mid Body.

DETAILS

- Flow Rate: 0.5 gpm (1.9 Lpm) (0.5GPM)
- Spray Type: Multi-Laminal (MLM)
- Sensor Type: Infrared
- Mounting Type: Single Hole
- Mounting Size: Single Hole 1-1/4" to 1-1/2"
- Trim Plate: 4" (102mm) (4)
- Power Supply: Battery (BAT)
- Temperature Mixer: Below Deck Thermostatic Mixing Valve (BDT)
- Finish: Polished Chrome (CP)
- Factory Default Timeout: 30 seconds
- Factory Default Gallons per Cycle: 0.25

FEATURES

ADA Compliant, Water Usage and Battery Strength Reporting,
 Wireless Settings Adjustment, Commercial Grade Faucet, Integrated
 Water Shut-off, Hygienic Line Flush, On-demand or Metered
 Activation, Self-adapting Sensor, Cast Brass Spout, Quick Connect
 Fittings

ELECTRICAL SPECIFICATIONS

- Battery Life: 3 years 8,000 cycles/month
 - Optional power harvesting significantly extends service life
- Sensor Range: 4" - 5" (102 - 127mm)
- Timeout Adjustment Settings: 30s

POWER SUPPLY OPTIONS

- 6VDC Plug Adapter (sold separately), 0362006*
 - 6VDC Ganged Adapter Kit (up to 6 units)(sold separately), 0362035*
 - 24VAC Box Transformer (up to 3 units)(sold separately), 0345370PK*
 - Optional Turbine Energy Harvesting
- * when converting units to hardwired with battery back-up

VIDEOS

- ▶ Sloan Connect App®
- ▶ Sloan Optima Below Deck Faucet

DOWNLOADS

- [Optima Smart Faucet Below Deck Installation Instructions](#)
- [Faucet Spray Heads Repair and Maintenance Guide](#)
- [ETF-80/880 and EBF-85/187 Below Deck Repair and Maintenance Guide](#)



Variation not shown: 4" Trim Plate

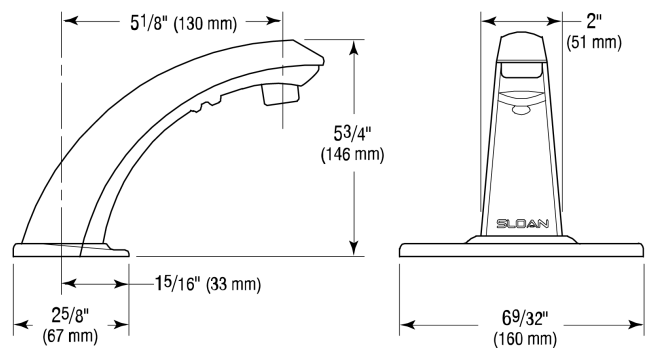

COMPLIANCES & CERTIFICATIONS



(ADA Compliant, ASME A112.18.1 Compliant, ASSE 1070,
 CalGreen Compliant, CEC Compliant, cUPC Certified, UPC
 Certified, UPC Low Lead Compliant, cUPC Low Lead Compliant,
 EPD, GPC 0.25 or less, HPD, IAPMO, WaterSense Listed,
 NSF-61, NYC604.4, Proposition 65, TAS, WELL Building
 Standard)

RECOMMENDED SPECIFICATION

Faucet shall include cast brass body, quick-connect fittings,
 twist-off/shut-off solenoid assembly, removable battery
 cartridge, flexible power supply and allow adjustment of
 settings wirelessly via Apple or Android smartphones.

NOTES

All information contained within this document subject to
 change without notice.

Looking for other variations of the EBF-187 product? [View the](#)

- [Trim Plate Guide](#)
- [Additional Downloads](#)

[general spec sheet with all options.](#)

[Find a matching soap dispenser for this faucet.](#)

[Find a compatible sink for this faucet.](#)

WARRANTY

[View Warranty Information](#)

ROUGH-IN

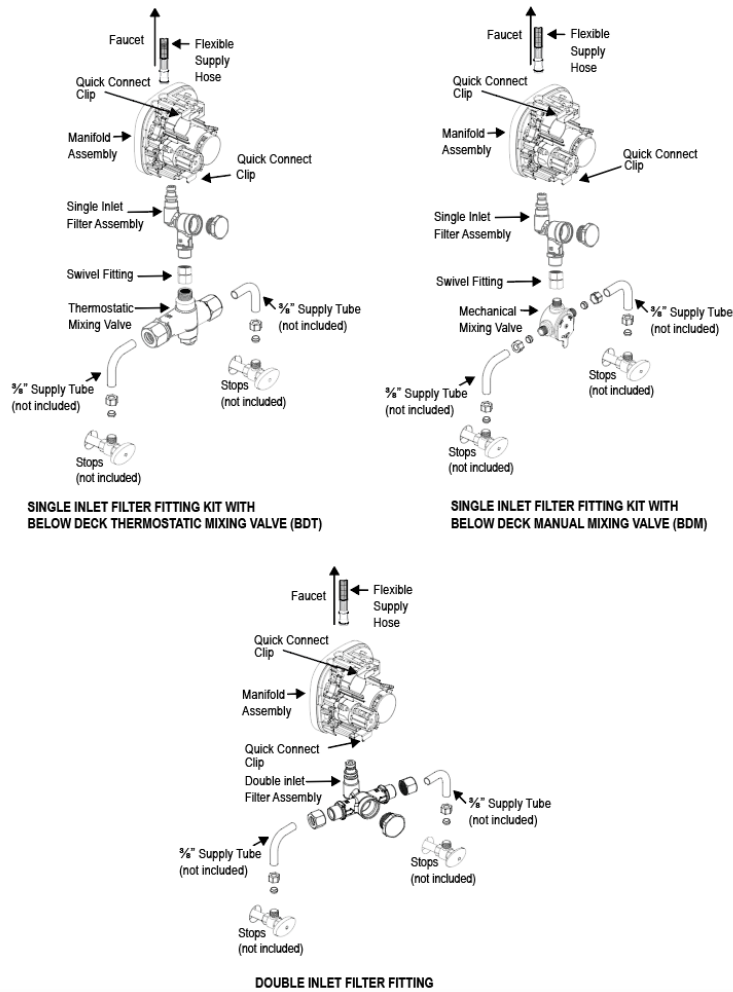

Sloan 10500 Seymour Ave, Franklin Park, IL 60131

Phone: 800.982.5839 • Fax: 800.447.8329 • sloan.com